

Vehicle Accident Prevention Awareness Package



Safety Prompts

Symbols are used throughout this module to highlight specific points, particularly those that involve safety. The symbols and their meaning are shown below.



DANGER

This prompt is used when there is an immediate hazard that **IS LIKELY TO** result in severe personal injury or death if proper procedures are not followed.



CAUTION

This prompt is used to warn against potentially unsafe practices that **COULD** result in personal injury or death and/or property damage if correct procedures are not followed.



NOTE

This prompt is used when an operation, condition, or information is of sufficient importance to warrant highlighting.



KEY CONTROL

This prompt is used to indicate where a Key Control has been identified in the training material.

Contents

| | |
|---|-----------|
| 1. Introduction | 1 |
| 2. Common hazards when operating vehicles | 2 |
| 2.1 Driving hazards | 2 |
| 2.2 Road design and maintenance hazards | 3 |
| 2.3 Traffic management hazards | 3 |
| 3. Controlling hazards associated with the use of vehicles | 4 |
| 3.1 Check the vehicle | 5 |
| 3.2 Training | 7 |
| 3.3 Fit for work | 7 |
| 3.4 Comply with road rules | 7 |
| 3.5 Housekeeping | 8 |
| 3.6 Drive to conditions | 8 |
| 4. Driving techniques | 8 |
| 4.1 Warning signals | 8 |
| 4.2 Safe transmission usage | 9 |
| 4.3 Steering | 9 |
| 4.4 Blind spots | 9 |
| 4.5 Speed | 10 |
| 4.6 Slowing and braking | 11 |
| 4.7 U-turns | 12 |
| 4.8 Cornering | 12 |
| 4.9 Overtaking and passing | 13 |
| 4.10 Reversing | 13 |
| 4.11 The 10 commandments of driving | 14 |
| 5. Parking | 15 |
| 5.1 Fundamentally stable | 15 |
| 5.2 Parking in operational areas | 16 |
| 5.3 Park-up for refuelling | 16 |
| 5.4 Dismounting from parked vehicle | 16 |
| 6. Loading a vehicle | 17 |
| 6.1 Load restraint | 17 |
| 6.2 Unloading | 18 |
| 7. Incidents involving vehicles | 18 |
| 7.1 Witnessing a vehicle incident | 18 |
| 7.2 Equipment runaways | 18 |
| 7.3 Wheel Runoff | 19 |
| 7.4 On-board fire | 19 |

| | | |
|-----|---|-----------|
| 7.5 | Emergency Response..... | 20 |
| 8. | Responsibilities..... | 20 |
| 9. | Appendix - Light vehicle checklist | 21 |
| 10. | Key Controls Index | 23 |

1. INTRODUCTION

Driving is something most of us do every day. It can also be one of the most dangerous things we do.

According to the Association for Safe International Road Travel (ASIRT), nearly 1.3 million people die in road crashes around the world each year. A further 20-50 million people are injured or disabled. Other consequences of vehicle accidents include:

- Psychological effects
- Cost (medical bills, time off work, etc)
- The effect on the family (emotionally and financially)
- Environmental damage from fuel spills
- Damaged to equipment and property
- Loss of production.



All OTML personnel, contractors and visitors operating or travelling in any vehicle while at work, or on their way to or from work, must demonstrate low-risk driving behaviours. These behaviours include:

- Planning the trip to allow sufficient time for travel and work commitments
- Ensuring that you are physically fit and competent to drive the vehicle
- Taking appropriate rest breaks
- Driving to the road conditions
- Being aware of and respectful to other road users.



This awareness package provides information regarding driver safety to prevent accidents arising from the use of vehicles, on and off site.

2. COMMON HAZARDS WHEN OPERATING VEHICLES

The hazards associated with operating vehicles will vary depending on the size of the vehicle, conditions, location and operator behaviour.

Some hazards caused by the environment may be out of the operator's control, for example road, weather or traffic conditions.

Other hazards relate directly to the operator's actions, for example ignoring traffic signs or driving too fast for rainy conditions.

2.1 DRIVING HAZARDS

Driving hazards can be categorised into 3 broad areas.

- **Environment**, including:
 - weather
 - road and ground conditions
 - road design (width, camber, slopes).
- **Vehicle**, including:
 - improper maintenance
 - tyre tread/wear/pressure
 - system failure
 - breakdown.
- **People** (drivers and pedestrians):
 - inattention (texting, listening to music)
 - inexperience
 - stress/emotions
 - over confident
 - under the influence of alcohol or drugs.



Common driving hazards and the associated risks include the following.

| Hazard | Possible risks and consequences |
|---|--|
| Emergency lane change due to vehicle stopping suddenly in front, a person on the road, or an object falling from a vehicle. | <ul style="list-style-type: none"> • Collision with other vehicle, obstacle or pedestrian • Single or multiple vehicle accident • Vehicle damage |
| Skidding from tyres not gripping the road (wet or icy conditions) or driving too fast for conditions. | <ul style="list-style-type: none"> • Single or multiple vehicle accident • Vehicle damage |
| Forced off road by oncoming traffic. | <ul style="list-style-type: none"> • Collision with other vehicle, obstacle, person • Roll over • Single or multiple vehicle accident • Vehicle damage |

2.2 ROAD DESIGN AND MAINTENANCE HAZARDS

Common road design and maintenance hazards and the associated risks include:

| Hazard | Possible risks and consequences |
|--|--|
| Narrow roads | <ul style="list-style-type: none"> Collision with other vehicle |
| Tight turns | <ul style="list-style-type: none"> Collision with other vehicle Roll over |
| Poor line of sight/obscured view (vehicles and pedestrians) | <ul style="list-style-type: none"> Collision with other vehicle, obstacle or pedestrian |
| Road surface wear and damage resulting in ruts, potholes, subsidence, uneven road surface etc. | <ul style="list-style-type: none"> Tyre or other vehicle component damage Loss of vehicle control |
| Adverse conditions (slippery wet road, poor visibility, glare, high winds) | <ul style="list-style-type: none"> Loss of vehicle control Collision with other vehicle or obstacle Roll over |

The Site Manager shall ensure designated routes are designed, constructed and maintained to a suitable standard, consistent with the duty required and nature of the vehicles using them. Access control, direction of traffic flow, right of way, speed limits and height restrictions will be determined by risk assessment, and adequately displayed.



2.3 TRAFFIC MANAGEMENT HAZARDS

Common traffic management hazards and the associated risks include:

| Hazard | Possible risks and consequences |
|---|--|
| Drivers not adhering to road rules and speed limits | <ul style="list-style-type: none"> Collision with other vehicle, obstacle or pedestrian Single or multiple vehicle accident Vehicle damage |
| Incorrect park-up | <ul style="list-style-type: none"> Uncontrolled vehicle movement Collision with other vehicle, obstacle, person Vehicle damage |
| Inadequate separation of vehicles and pedestrians/pedestrian movement | <ul style="list-style-type: none"> Collision between vehicle and pedestrian Injury Fatality Vehicle damage |
| Livestock (domestic, farm, native animals) movement | <ul style="list-style-type: none"> Collision between vehicle and livestock Injury or fatality (of livestock and/or operator) Vehicle damage |

Signposting, signalling, surface marking, lighting (illumination) and barrier protection of equipment and adjacent work areas are provided, as identified by a risk assessment. Where possible pedestrians will be segregated from motorised vehicles and heavy and light vehicles will also be separated.



Special arrangements will be used when traffic flow is restricted. These arrangements may include:

- Additional communication with affected personnel
- Alternate routing
- Additional signage
- Traffic control personnel, speed humps, gates and barriers
- Additional supervision.



3. CONTROLLING HAZARDS ASSOCIATED WITH THE USE OF VEHICLES

Hazard control methods are chosen according to the hierarchy of controls. Controls are applied starting with the most effective and then working down the hierarchy to the least effective. Some of these controls, particularly higher level controls, are implemented at the management/supervisor level (e.g. approval of vehicles used on site, developing procedures, designation of vehicle routes, parking areas, etc). But many controls are implemented by the operator.

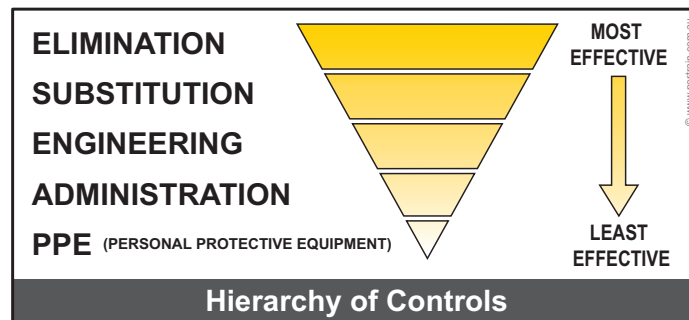

The most effective level of control is to **ELIMINATE** the hazard completely. Is it possible to do the required task without using a vehicle?

In most cases this is not possible, in which case other control methods must be used. Below are some examples.

SUBSTITUTION: Can you use a less hazardous vehicle, or take a less hazardous route?

ENGINEERING and ISOLATION: Use vehicles that have Roll Over Protection (ROPs), Falling Object Protection (FOPs) and vehicle occupant protection (airbags, seatbelts). Use vehicles that are fit for purpose and well maintained. Use designated parking, loading/unloading and maintenance areas that are isolated to prevent unauthorised access. Separate parking areas for light and heavy vehicles may be provided.

ADMINISTRATION: Operators must be trained and authorised for the vehicle they will be using. Operators must follow relevant procedures and adhere to signage and safety regulations.

PPE: Wear a seatbelt while driving or travelling in a vehicle. In areas where vehicles and pedestrians may mix, pedestrians must wear hi-vis clothes. Safety helmets must be worn by personnel operating motorised or manual cycles/bicycles



The best way to operate the vehicle safely is for the operator (you) to:

- Know your vehicle/equipment
- Be authorised and competent to use it
- Be fit for work
- Comply with road rules
- Comply with site safety requirements
- Recognise changing conditions and adjust your driving/operating technique to suit.

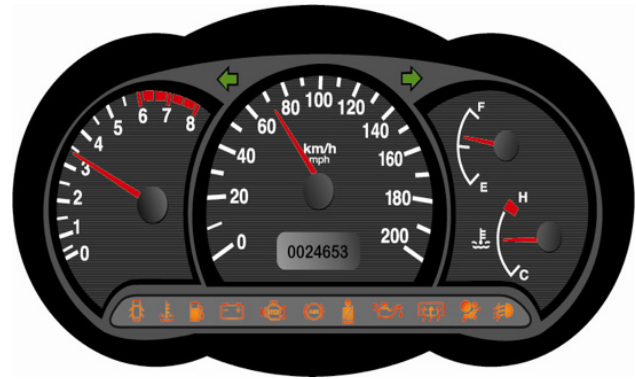

3.1 CHECK THE VEHICLE

All vehicles used on site must be registered and insured in accordance with relevant local regulations. Vehicles must also be approved for use on site.



Scheduled servicing helps to prolong the useful life of equipment and components and ensures equipment performs as expected.

As the operator, you must be familiar with the vehicle specifications and limitations, including safe working load limits, and work within the equipment limits and capacity. This information will be in the vehicle manufacturer’s manual - there should be copy in the glovebox of each vehicle you operate. If not, talk to your supervisor.

3.1.1. CONDUCT A PRE-START

Using the manual and a suitable checklist (see Appendix), do a walk around inspection of the vehicle before operating it. Start at the drivers door and go completely around the vehicle, finishing in the operator cabin. Check:

- No damage to body, clean tray
- Lights / signals clean and undamaged
- Tyres (including spare) properly inflated / good tread / no cracks or deformation
- Wheel nuts, wheel studs and mounts are secure / none missing or damaged.
- No fluid leaks under /around vehicle
- No obvious damage to chassis, suspension
- Windows clean / no cracks
- Security of bullbar, winch, whip, snorkel, spotter lights, flashing beacon, etc
- Fluid levels as per manual.

Enter the vehicle cabin and check:

- Vehicle authorised for site
- No Out of Service, Danger or Information Tags
- Cabin clean and free of debris
- Seatbelt undamaged
- Mirrors clean and undamaged
- Check vehicle is in park and brake is applied

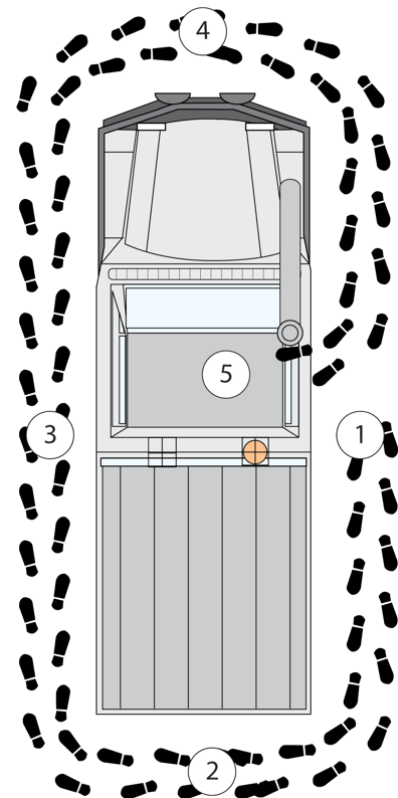

OHS & T

Start engine and check:

- Instrument gauges and warning lights
- Operation of lights, washer/wipers, brakes and steering
- Two-way radio is operational (all vehicles on site must have a working two-way radio installed).

Use all your senses during start-up and operation. If something doesn't seem right, it probably isn't.

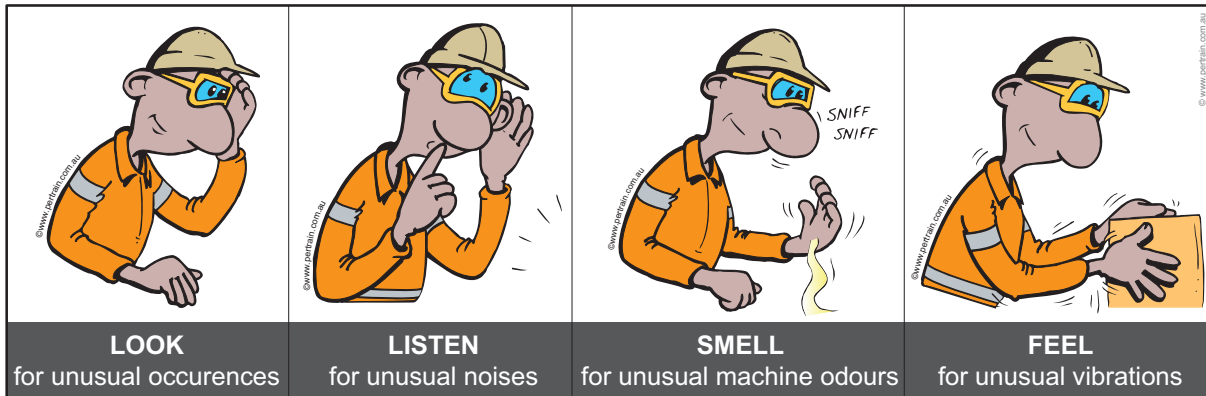

3.1.2. REPAIR / REPORT DEFECTS OR DAMAGE

Do not use damaged or faulty equipment.

- Remove the key.
- Put an Out of Service tag on the steering wheel.
- Report the fault/damage to your supervisor or maintenance.

Advise your Supervisor if you think the equipment assigned to you is not suitable to the task.



NOTE

Do not operate a vehicle that you feel is not safe.

If you are operating the vehicle when you notice something does not seem right:

- Pull over to a safe area
- Apply the park brake
- Stop the engine
- Contact your supervisor or maintenance.

If you must stop on a road, keep as far to the side of the road as possible, and make yourself as visible as possible.

- Keep the rotating beacon light and head lights on.
- Turn on the hazard lights.
- Place reflective triangles, lights or similar before and after the vehicle (if it is safe to do so).
- Advise other road users of your location using the radio.



NOTE

It is the operator's responsibility to keep the vehicle clean (dirt can hide defects) and to ensure that servicing is carried out as scheduled. Advise your supervisor if the vehicle you are operating is due to be serviced, or has missed a service. Keep a record of all vehicle inspections, maintenance and servicing.





3.2 TRAINING

Drivers must only operate vehicles for which they are trained and permitted, licensed (in accordance with the relevant local regulations) or authorised. All drivers shall be responsible for the safety of their passengers. Advise your supervisor immediately if you lose your licence/authorisation for any reason.

Additional driver training, including site and route familiarisation and defensive driving techniques may be required. Participate fully in all training opportunities, not just for safety but also for your own personal and professional development.



3.3 FIT FOR WORK

You must be fit to perform your job. Some roles require a pre-employment medical as well as ongoing health assessments.

Being fit for work includes not being under the influence of alcohol or drugs and not being fatigued or stressed to an extent that it affects your work.

It is an offence for any person to drive in Australia with a blood alcohol level above 0.05%.

OTML has a ZERO TOLERANCE for persons under the influence of alcohol and drugs in the workplace.

You must also:

- Take a rest break every two hours during trips longer than two hours duration
- Stop and rest if you are feeling fatigued when driving
- Contact your supervisor if you feel as though you are not safe to drive due to fatigue.



3.4 COMPLY WITH ROAD RULES

All personnel must:

- Wear a seatbelt when driving or travelling as a passenger
- Obey posted speed limits and reduce speed if conditions deteriorate
- Obey local road regulations
- Give way to emergency vehicles displaying their emergency lights
- Operate the vehicle with care and in a manner appropriate with the road and traffic conditions
- Maintain a 50m distance between vehicles when travelling on site roads.





3.4.1. MOBILE PHONE USE

It is an offence to use a mobile phone when driving a vehicle unless it is through a hands-free device.

- The hands free mode must be used to receive or initiate calls.
- Mobile phones must be set to 'auto-answer'. If your device does not have this feature, it is not permitted for use.
- Where possible, make or answer calls when the vehicle is stopped in a safe position.



3.5 HOUSEKEEPING

Don't allow rubbish and waste to build up. Clutter and litter in the cabin can be dangerous as it can:

- be a fire hazard
- interfere with operation of the controls / pedals
- become a missile and cause injury in an accident / rollover situation.

Clean as you go. Remove fire and slip hazards such as oil, grease and other materials immediately. Clean funnels, nozzles, filling and greasing equipment before use to prevent contamination.

3.6 DRIVE TO CONDITIONS

Road conditions can change quickly and with out warning. Be alert for changes in the weather, road surface and surroundings. Drive more slowly in adverse conditions, or if you are unfamiliar with the area.

4. DRIVING TECHNIQUES

Safe driving techniques, sometimes called defensive driving, include (but are not limited to) the following:

- Operating the vehicle in a safe manner
- Monitoring vehicle indicators and gauges to ensure vehicle is operating within its limits
- Responding promptly to any alarms and indicators by rectifying any faults that you are authorised to fix in accordance with manufacturer guidelines or reporting the issue for maintenance to fix.

4.1 WARNING SIGNALS

When you are in an operational area, be aware of equipment around you and listen for audible warnings such as horn or reversing signals that indicate close proximity to other vehicles. If you are a pedestrian, stand well clear of equipment and allow an extra safety margin — you may be in the driver's blind spot. Ensure that you can be seen at all times.

Operators of mobile equipment indicate their intention to start and intended direction of movement using the following horn signals:

- one blast before starting the engine
- two blasts before moving forward
- three blasts before reversing.

Wait 5-10 seconds before moving off to enable nearby personnel to move to a safe location.



4.2 SAFE TRANSMISSION USAGE

Correct use of the transmission, whether it is automatic or manual, is crucial to the safe, efficient operation of the vehicle. Make smooth and appropriate manual gear changes. Do not rest your foot on the clutch pedal. This will result in increased clutch wear.

Select the correct gear before approaching a hazard, intersection, corner or steep descent. This will free both hands for steering control and will enable you to concentrate on driving.



CAUTION

You have less control at high speed and in a high gear ratio.

4.3 STEERING

Both hands should be placed on opposite sides of the steering wheel (e.g. left hand between 8 and 10 o'clock and right hand between 2 and 4 o'clock). Use the hand-over-hand technique when turning sharp corners. Then straighten out the steering wheel by hand. Do not let the wheel slip through your fingers.

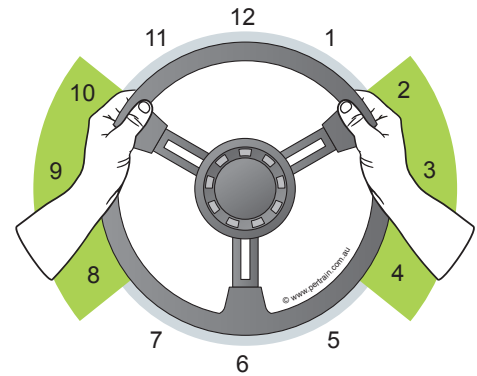

4.4 BLIND SPOTS

Blind spots are the areas not visible from the driver's seat that may hide other vehicles, machines, pedestrians and obstacles. The following sequence of photos illustrates shows the view from the operator seat of a haul truck when it is parked. The fourth photographs shows that there are 2 light vehicles and 6 people in close proximity to the truck, none of which can be seen from the drivers seat.



OHS & T

Follow these guidelines.

- Before moving off, check the area around your vehicle for other vehicles or personnel.
- Look over your shoulder before moving off, changing direction, turning corners or overtaking. This is preferable to using your mirrors in many cases.
- As you move off, look ahead and check your path is clear.
- Check the rear view mirror as you drive.
- Keep a sharp watch to the left and right.
- Use a spotter in tight areas when necessary, especially when reversing.
- Drive to suit the conditions.

As a pedestrian you must:

- Maintain a safe distance / separation from mobile plant and equipment
- Assume the driver can not see you
- Remain in designated walkways around buildings and infrastructure
- Not position yourself between vehicles or between structures and vehicles
- Wear Hi-vis clothing so vehicle operators can see you.

4.5 SPEED

Excessive speed multiplies the chances of getting into trouble and decreases the amount of time you have to react to a situation. For example:

- double the speed = 4 times the braking distance.
- triple the speed = 9 times the braking distance.

Greater speed also increases the impact if you hit something, increasing the risk of injury or death.

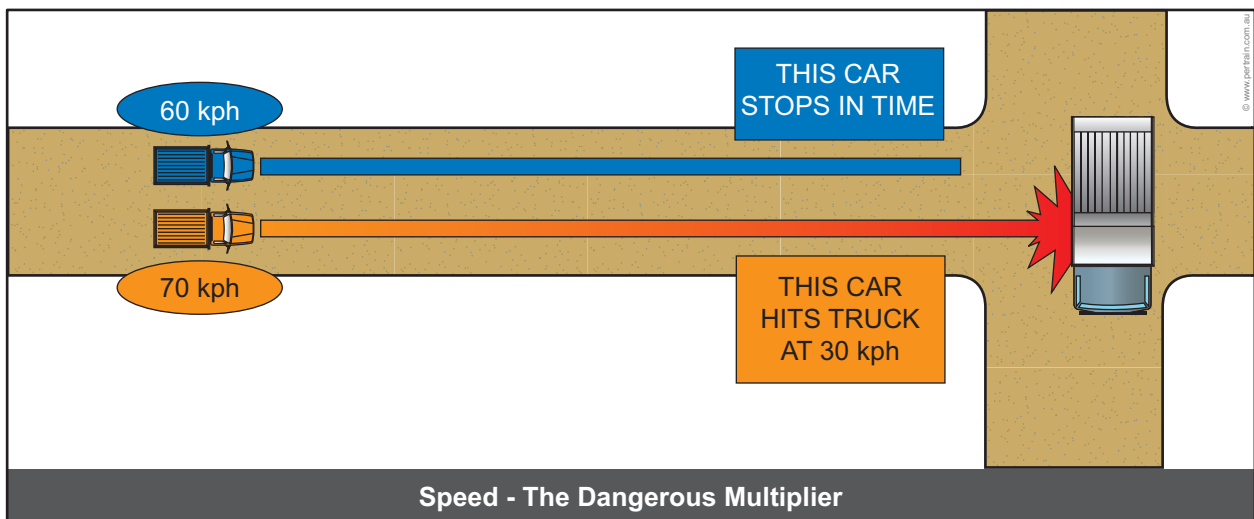

For example:

- To stop a standard 100 series Land Cruiser (2550 kg tare weight) at 110 km/h in ideal conditions (without considering perception and reaction time) will take approximately 55 metres.
- To stop when travelling 60 km/h in ideal conditions will take approximately 49.2 metres.
- If the vehicle in front stops suddenly (and you are travelling 50 metres behind) you will stop within 80 cm of the vehicle as long as conditions are ideal and your braking is effective.

4.6 SLOWING AND BRAKING

Slow the vehicle using a combination of throttle control, appropriate downshifting techniques and brake application. The stopping distance is affected by the **driver reaction time** and the **braking distance**.



4.6.1. DRIVER REACTION TIME

The driver’s reaction time is the time it takes from recognising a hazard until the time the brake is actually applied. Typically this is about three quarters of a second.

4.6.2. BRAKING DISTANCE

The braking distance is the distance the vehicle travels after the brake is applied until it stops. This distance depends on the ability of the brake lining to produce friction, the brake drums to dissipate heat and the tyres to grip the road. If the heat in the brakes becomes too great, braking effectiveness is reduced.

The heavier the load and the faster the speed, the longer will be the stopping distance and the greater the force required to stop the vehicle.

The following are some key considerations when braking.

| Technique | Key points |
|---|--|
| Brake early and gradually | <ul style="list-style-type: none"> Apply the brakes early for smoother stops, greater control and less wear on the brakes. Braking early also makes the vehicle movement more predictable, and therefore safe for other personnel. |
| Brake in a straight line | <ul style="list-style-type: none"> The greater the effort of brake application required, the more important it is to ensure that the vehicle is travelling in a straight line. Always brake before entering a turn, not during the turn. Braking on bends is dangerous due to the risk of skidding or overturning and should only be carried out in an emergency. |
| Allow for the load | <ul style="list-style-type: none"> Adjust braking techniques for different loads. |
| Match vehicle braking to the road surface | <ul style="list-style-type: none"> Adjust your braking techniques to suit the road conditions. Allow extra braking distance and brake smoothly if the road surface is wet or slippery. |
| Ease off as the vehicle slows | <ul style="list-style-type: none"> Ease off the brake pedal as the vehicle slows as it takes less braking effort to continue slowing at the same rate. If the brake pedal is not eased off, the vehicle will come to an abrupt or violent stop and could possibly lock the wheels in slippery conditions. |

4.7 U-TURNS

Before attempting a U-turn, ensure that there is no following or oncoming traffic for at least 200 metres.

Enter the U-turn using only sufficient power to accomplish the turn smoothly. Do not enter the U-turn at speed and under power, as this can result in damage to the vehicle or a rollover.



NOTE

U-turns are prohibited on some site roads. U-turns can only be undertaken at traffic lights on public roads where signage specifically allows.

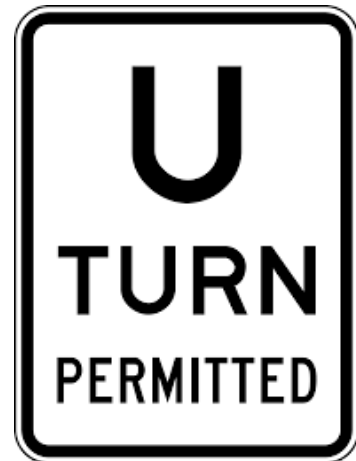

4.8 CORNERING

Conduct turns at low speed with a small turn radius or at operational speed with a larger turn radius (as normally encountered on the road). The rate or speed of entry into a turn, coupled with the vehicle weight and the distribution of that weight over the drive and steer axles, will determine how the vehicle will steer.

When approaching a bend or turn, observe the following guidelines.

1. Slow the vehicle speed down to a point where you are certain you can safely negotiate the corner. Your decision on how much to slow down will be based on:
 - curve of the bend
 - road surface condition
 - visibility entering the corner
 - width of road available to you.
2. Decelerate into the corner and accelerate out.
3. When you approach a left bend or corner, position the vehicle as far to the right on your half of the road as practicable. This gives you better vision around the bend, makes for a straighter line of travel through the corner and less steering lock will need to be applied. This also generates less body roll, weight transfer and subsequent loss of stability.
4. Maintain the most constant radius possible after you have entered the corner. This prevents the vehicle from becoming unbalanced in the tightest part of the corner.
5. As you exit the turn, smoothly return the steering to a straight position to return the vehicle weight evenly back over the wheels.

4.9 OVERTAKING AND PASSING

Use the following guidelines when overtaking.

| | |
|---------|--|
| Stage 1 | <ul style="list-style-type: none"> Do not attempt to overtake unless you can see for 100 metres in front of the vehicle you are passing. Ensure that the minimum 50 metre safe distance with the vehicle in front is maintained before overtaking. Contact the vehicle ahead by two-way radio before attempting to pass. Wait for acknowledgement before starting the manoeuvre. Use the indicator to signal before overtaking. |
| Stage 2 | <ul style="list-style-type: none"> Move into the oncoming lane if there is still no oncoming traffic. Maintain constant visibility of any oncoming traffic. Keep a safe distance from the other vehicle as you move past. |
| Stage 3 | <ul style="list-style-type: none"> Ensure that there is a 50 metre safe distance between you and the other vehicle before signalling again and returning to the correct lane. Turn off the indicator signal. |

Use the **MLBMLC** method when changing lanes:

- **M**irror
- **L**ook
- **B**linker
- **M**irror
- **L**ook
- **C**hange.

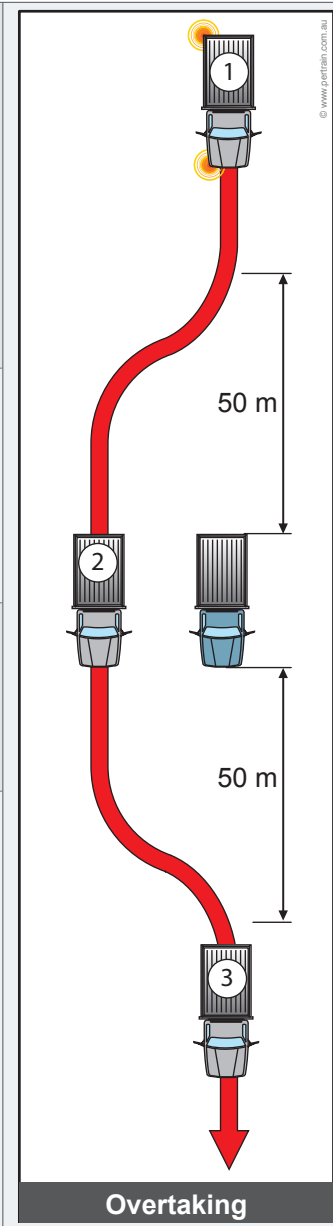

4.10 REVERSING

Use the rear-vision mirrors and reversing camera (if installed) as well as your eyes. Look all around you before reversing. Remember that items in the mirrors may be closer than they appear.

Some vehicles are fitted with audible beepers and proximity detectors to help notify you when objects are near.

When reversing in a tight situation, use a spotter to guide you. Maintain minimum clearance on the near side (driver side). You can then be confident that there is sufficient clearance on the off-side of the vehicle. Continually check the off-side mirror when performing this manoeuvre, to ensure that no obstructions are present.

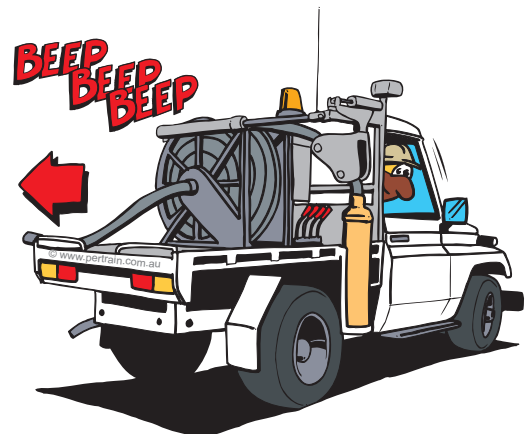

**NOTE**

Have a competent person (spotter) with a clear view of the sides and rear of the vehicle direct you. The spotter can also assist in keeping people away from the area while you are reversing.



4.11 THE 10 COMMANDMENTS OF DRIVING

Follow the 'Ten Commandments of Driving'.

| TEN COMMANDMENTS | |
|------------------|--|
| 1. | <p>LOOK UP AND READ AHEAD</p> <ul style="list-style-type: none"> • Anticipate. • Look up the road as far as possible. |
| 2. | <p>TRUST NO ONE</p> <ul style="list-style-type: none"> • Never assume what the other driver will do. • Abilities and skills of drivers vary enormously and anyone can make a mistake. |
| 3. | <p>LEAVE A SAFETY CUSHION WHEN STATIONARY</p> <ul style="list-style-type: none"> • A safety cushion or buffer around your vehicle (especially ahead of you) gives you a margin for error - your's and the other driver's. |
| 4. | <p>LEAVE A SAFETY CUSHION WHEN MOVING OFF</p> <ul style="list-style-type: none"> • When the car in front starts to move, count '1, 2' before you begin to move, giving you time to check ahead both ways, before moving off. |
| 5. | <p>LEAVE A SAFETY CUSHION WHEN MOBILE</p> <ul style="list-style-type: none"> • Observe the two second rule - pick a landmark and make sure that you pass it no sooner than 2 seconds after the vehicle in front of you. • At any speed you should be at least two seconds behind the vehicle in front |
| 6. | <p>CHANGE LANES BY THE 'MLBMLC' SYSTEM</p> <ul style="list-style-type: none"> • Use the "Mirror - Look - Blinker - Mirror - Look - Change" sequence of actions when changing lanes. |
| 7. | <p>USE YOUR MIRRORS WHEN DRIVING</p> <ul style="list-style-type: none"> • Check your mirrors regularly and often, approximately every 10 seconds, so that you know what is happening around you. |
| 8. | <p>USE YOUR MIRRORS BEFORE BRAKING</p> <ul style="list-style-type: none"> • Check what is happening behind you before you brake. |
| 9. | <p>KNOW YOUR ROAD LAWS</p> <ul style="list-style-type: none"> • Be aware of the current laws. • Use common sense and good judgement at all times. |
| 10. | <p>CONCENTRATE</p> <ul style="list-style-type: none"> • Give driving your full concentration. |



5. PARKING

Park in designated parking areas. There may be separate parking areas for light and heavy vehicles.

Vehicles must only be left unattended when parked in designated parking areas with the engine turned off. Implement controls (eg. control of access to ignition keys, wheel chocks) to prevent inadvertent or unintended movement of the vehicle while in parking areas, during loading / unloading, during maintenance.



5.1 FUNDAMENTALLY STABLE

When stopping the vehicle, make sure that it is **Fundamentally Stable**. This means that the vehicle will not roll or move when the transmission is in neutral and the park brake is not applied.

Once the vehicle is stable:

- Shift the transmission into the correct gear (Park, Neutral or Reverse)
- Apply the park brake
- Turn the engine off
- Secure the vehicle by removing the key and locking the doors.



Follow these guidelines when parking the vehicle.

- Park equipment in accordance with the manufacturer's recommendations.
- Where practical, vehicles should be parked on level ground, clear of traffic flow, and visible to other road users.
- Park in a V-drain, over a hump or turn front wheels into the kerb or embankment to stop uncontrolled movement.
- Lower attachments (if applicable) to prevent uncontrolled movement
- Chock wheels to prevent uncontrolled movement.
- Try to park the vehicle so that you can go forward when leaving the parking space.
- Do not leave the vehicle while there are passengers in it.
- Do not leave a running vehicle unattended.
- Adhere to signage requirements, e.g. Reverse Park Only, Heavy Vehicle Parking.



5.2 PARKING IN OPERATIONAL AREAS

Where park-up in an operational area is necessary, follow these additional guidelines.

- Do not park within 50 metres of operating machines (unless in a designated parking area)
- Make positive contact with operating vehicle/equipment operators before entering the area
- Park on safe and level ground wherever possible
- Leave rotating beacon on.

DO NOT park a vehicle:

- Where it will create a hazard for other traffic
- At the rear of other parked equipment where your vehicle cannot be clearly observed
- Near a corner as vehicles rounding the corner may not see your vehicle.



5.3 PARK-UP FOR REFUELLING

The following safety precautions apply when refuelling a vehicle.

- No smoking, naked flames or mobile phone use in the refuelling area as this could spark a fire or explosion.
- Coordinate the operation with other personnel in the work/refuelling area.
- Only refuel at a designated fuel bay.
- Approach the refuelling area at low speed.
- Follow safe driving practices when manoeuvring to the fuel bay.
- When in position, put the transmission in correct gear and apply the park brake.
- Shut down the engine.
- Dismount and leave the vehicle cabin, but stay with the vehicle while it is being refuelled.



NOTE

Passengers must not remain in the vehicle while it is being refuelled.

5.4 DISMOUNTING FROM PARKED VEHICLE

Injuries can occur when footing is lost as a result of material accumulating on steps, or grease build-up on handrails causes you to lose your grip.

- Dismount where ladders, non-slip steps and hand holds are provided.
- Inspect, clean and repair steps and hand holds before mounting.
- Face towards the machine when dismounting.
- Maintain three point contact with steps and handrails (two feet and one hand or one foot and two hands).
- Never dismount when a machine is moving and NEVER jump off.
- Do not use controls as hand holds.
- Keep your body and clothing clear of pinch points.
- Before stepping off, check the ground for loose rocks and water.



6. LOADING A VEHICLE

Correct loading of vehicles is vital to prevent injury to drivers and members of the public and damage to the load and equipment.

- Keep within the legal requirements for weight, length and width for the load.
- Ensure the maximum safe load limits (as per the vehicle manufacturer manual) are not exceeded.
- Spread the weight of the load evenly across the axles.
- Keep the centre of gravity as low as possible.
- Place larger and heavier items at the bottom and in front of lighter crushable items.
- Check that the dimension of the vehicle and load does not exceed any clearances along the route, e.g. overhead powerlines, bridges, narrow tunnels.
- Rear overhang loads must not exceed the limitations specified by road regulations. Make any overhang conspicuous by fixing a red flag or other suitable device clearly visible as a warning. At night consider fixing a light or reflective surface to the overhang.



NOTE

You are legally responsible for your load and any damage or injury that may be caused by poor loading or transport methods.

6.1 LOAD RESTRAINT

The load restraint system used must be capable of preventing movement of the load during forward deceleration (e.g. emergency braking), rearward deceleration (braking during reversing) and sideways or lateral acceleration (when cornering or on cambered roads).



Loads may be restrained using the tie down method or direct restraint method or a combination..

6.1.1. TIE DOWN METHOD

This is the most common form of load restraints and involves the use of tie down lashings (webbing, chains, etc).

The load is prevented from moving by friction between the load and the vehicle. The friction force prevents the load moving forward, rearward and sideways. The lashings are tensioned to clamp the load to the vehicle and to prevent the load from moving upwards. Make sure tray is clean before loading to assist with friction.

6.1.2. DIRECT RESTRAINT METHOD

A load can be directly restrained by containing (e.g. in a trailer or dump body) or blocking (stacking against a structure or other packing) the load. This is the best method for securing loads that are difficult to tie down. Specially constructed bodies and equipment (such as curtains, nets, loading racks and bulkheads) can reduce the amount of time needed to restrain loads.

6.2 UNLOADING

When stopping or parking to allow passengers to disembark or to unload cargo, consider:

- other traffic in the area
- ground condition (e.g. unstable, wet, slippery)
- other work being conducted in the area (e.g. hot work, scaffolds, ladders).



7. INCIDENTS INVOLVING VEHICLES

Any action you take in responding to an incident must not make the situation worse. You must:

- NOT place yourself in unnecessary danger
- NOT inflict further injuries when moving an already injured person
- Understand, memorise and use the correct emergency procedures
- Contact your supervisor
- Place hazard signs to warn others of an immediate hazard.

7.1 WITNESSING A VEHICLE INCIDENT

If you are first on the scene of a vehicle incident, do not disturb the vehicle(s) or the incident site, except to save someone's life or to prevent further injury.

- Activate hazard lights, or place safety cones (if possible) on either side of the incident as a warning to other vehicles.
- If someone has been seriously injured, administer first aid (DRSABCD) and contact the relevant authority. (The authority will vary depending on whether you are off or on site).
- Give accurate information about the incident and any injuries, and provide directions to the site.
- Where possible, arrange for another vehicle to meet and escort emergency vehicles to the scene.
- If an incident happens off site, make a full record of the incident (time, place, details) and collect the other driver's information including:
 - name and address
 - licence number
 - registration details
 - insurance company details.
- If the incident happens on site, follow the site incident reporting procedure.

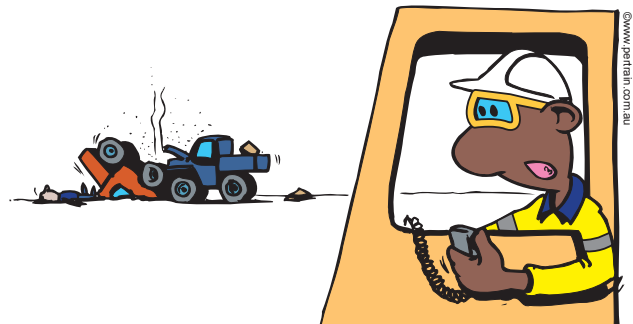

7.2 EQUIPMENT RUNAWAYS

If you lose control of a vehicle while driving:

- Apply the brakes
- Change down gears to reduce speed if the situation allows
- Ease the vehicle into a wall or other safety barricade.

Do not engage the transmission in the opposite direction to the vehicle movement as the engine could stall. This will result in no engine braking or service brakes and loss of steering control through the hydraulic system.



DANGER

DO NOT attempt to jump from, or leave, a moving vehicle. NEVER attempt to board a runaway vehicle as the risk of being run over is extreme.

7.3 WHEEL RUNOFF

If a wheel comes off while you are driving:

1. Don't panic! stay calm.
2. Keep your hands on the wheel, ready for when you regain control of the vehicle.
3. Keep your eyes open, you need to see where you are going.
4. Shift into Neutral, to stop power to the wheels.
5. Steer into the skid. Steer in the direction that the back of the vehicle is going.
6. Don't slam on the break, let the vehicle slow on its own.
7. Drive out of danger before stopping the vehicle and getting out.
8. Contact your supervisor or maintenance and follow their instructions.
9. Complete an incident report according to procedures.
10. Make sure that the vehicle is taken to the workshop to check wheel nuts/lugs as soon as possible after the incident.

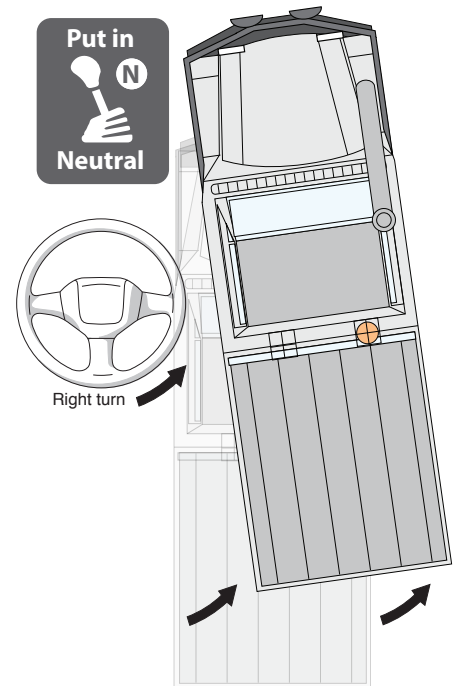

7.4 ON-BOARD FIRE

If a fire breaks out on the vehicle you are operating:

1. Stop in the safest place possible.
2. Lower load/attachments to the ground (if applicable)
3. Put the vehicle in neutral and apply the park brake
4. Shut down the engine using the emergency stop button (if applicable) or using the ignition key.
5. Where fitted activate the on-board fire suppression system (if it does not automatically activate).
6. Use the radio to initiate an emergency call.
7. Evacuate the vehicle cabin before the fire suppression powder runs out. Use the exit away from the fire. This may mean breaking a window or the windscreen to avoid the flames.
8. If it is safe to do so, take the hand held fire extinguisher with you and attempt to put out the fire.
9. If unable to extinguish the fire, or as soon as the fire extinguisher runs out, withdraw a safe distance from the vehicle.
10. Set up an exclusion zone to stop other personnel going near the fire and wait for emergency personnel to arrive.



**DANGER**

Do not attempt to fight the fire if it is unsafe. Do not put yourself at risk. Never attempt to fight a tyre fire or a fire where there are other hazards such as explosives or chemicals in the area. Initiate an emergency response immediately and evacuate the area. Wait for emergency response personnel to arrive.

7.5 EMERGENCY RESPONSE

Emergency response personnel are trained and authorised to react in a variety of incident and emergency scenarios in line with the OTML Emergency Response Plan. Responses may include:

- fire fighting
- hazardous chemical spill response
- search and rescue
- rescue operations involving collapsed structures, confined spaces and heights.

Emergency response personnel are trained to operate rescue equipment, including first aid and trauma kits, stretchers, fire fighting equipment, vertical rescue rope systems and extraction equipment such as cutters and spreaders (jaws of life).



8. RESPONSIBILITIES

Personnel, contractors and visitors are responsible for operating vehicles safely and efficiently by:

- obeying the road rules
- avoiding alcohol and drugs when in operation of a vehicle
- driving vehicles that are inspected regularly and roadworthy
- being considerate of other road users
- driving to conditions
- parking in designated parking areas and ensuring that the vehicle is fundamentally stable
- reporting all incidents.



9. APPENDIX - LIGHT VEHICLE CHECKLIST

MOBILE EQUIPMENT INSPECTION CHECKLIST LIGHT VEHICLE

Light Vehicle: Any item of plant that may be registered and driven on a public road and of no greater than 8 tonne gross vehicle mass.

| | | | |
|--|--------|-----------------------------------|------------------|
| INSPECTION SHEET NO: | | Date: ___/___/___ | |
| Site Name: | | Site Permit Request Number: | |
| OTML REPRESENTATIVE DETAILS | | | |
| Name: | | Role: | Department: |
| EQUIPMENT DETAILS (Refer Permit Request Form Section A) | | | |
| Company Name: | | | |
| Equipment Description: | | | |
| | | SMU (hrs): | Odometer: |
| Equipment Make: | Model: | Serial: | Registration No: |
| Intended area of use at site: | | | |
| Intended use at site: | | | |
| <p>The following mobile equipment criteria must be achieved prior to approval being granted for the item of mobile equipment to be operated in the approved area of site within its intended use. Indicate where the item of mobile equipment achieves compliance with 'Y' (Yes) or 'N' (No) where it fails to achieve compliance. Failure to achieve compliance in each of the required compliance criteria will result in the permit to site not being approved until that compliance issue has been rectified to the satisfaction of the OTML Representative.</p> | | | |

Refer Mobile Plant and Equipment Standard for further guidance on compliance criteria

| | |
|---|---|
| EQUIPMENT DOCUMENTATION (Refer Permit Request Form Section A and B: Select 'n/a' (not applicable) where not required) | |
| OEM Operating Instructions <input type="checkbox"/> Y <input type="checkbox"/> N (including Pre-Start Checklist and maintenance criteria) | |
| Registrable Classified Plant Certification <input type="checkbox"/> Y <input type="checkbox"/> N <input type="checkbox"/> n/a | Undiluted Exhaust Emissions Test <input type="checkbox"/> Y <input type="checkbox"/> N <input type="checkbox"/> n/a |

| | | * denotes required | Compliance | Area Requirements | | |
|--------------------------------------|---|----------------------|------------|-------------------|----|---------------------------------------|
| | | | Y/N | SO | OC | UG |
| 1. GENERAL | | | | | | |
| 1.1 | Company Logo/Name displayed | | | * | * | * |
| 1.2 | Machine Identity/Equipment No. displayed in prominent positions | | | * | * | * |
| 1.4 | First Aid Kit fitted in cab | | | * | * | * |
| 1.5 | Seat Belts fitted | | | * | * | * |
| 1.6 | Horn fitted | | | * | * | * |
| 1.7 | Four-Wheel Drive displayed in prominent positions | | | | * | * |
| 1.8 | Registration/Local Authority complaint (if applicable) | | | * | * | * |
| 2. COMMUNICATION | | | | | | |
| 2.1 | Two-Way Radio fitted or hand held to site communication requirements (applicable to vehicle type) | | | * | * | * |
| 3. SAFETY DEVICES | | | | | | |
| 3.1 | Flashing Beacon | | | * | * | * |
| 3.2 | Reversing Alarm fitted | | | * | * | * |
| 3.3 | Additional Reversing Lights fitted | | | | * | * |
| 3.5 | Fixed Aerial (4m) with coloured flag (if vehicle height <4m) | | | * | * | * |
| 3.6 | Battery Isolator fitted | | | * | * | * |
| 4. FIRE SUPPRESSION EQUIPMENT | | | | | | |
| 4.1 | 1.5 kg DCP Fire Extinguisher located in cab | | | * | | |
| 4.3 | 4.5 kg DCP Fire Extinguisher located on vehicle | | | | * | * |
| 4.7 | Fixed AFFF/FFFP Fire Suppression System on vehicle | System Type: | | | | * Turbo charged LV and engine >100 kW |
| | | Capacity (l): | | | | |
| | | Fail Safe (Y/N) | | | | |
| | | Auto-Detection (Y/N) | | | | |
| 4.8 | Fire Extinguisher Inspection Dates current (1 yearly) | | | * | * | * |
| 5. BRAKING SYSTEMS | | | | | | |
| 5.1 | Braking System free from visible leaks and not modified from OEM specifications | | | * | * | * |
| 6. STEERING SYSTEMS | | | | | | |
| 6.0 | Steering System free from worn/damaged components, serviceable and not modified from OEM specifications | | | * | * | * |



MOBILE EQUIPMENT INSPECTION CHECKLIST LIGHT VEHICLE

| | | * denotes required | | Compliance | Area Requirements | | |
|-----------------------------------|--|--------------------|--|------------|-------------------|-----|-----|
| | | | | Y/N | SO | OC | UG |
| 7. VEHICLE EMISSIONS | | | | | | | |
| 7.1 | Diesel Engine powered | Power (kW) | | | | * | * |
| 7.2 | Exhaust Emissions Test under full load conditions | NOx (ppm) | | | | | * |
| | | CO (ppm) | | | | | |
| 8. CABIN/CANOPY | | | | Y/N | SO | OC | UG |
| 8.4 | Passenger Protection within cabin/canopy | | | | * | * | * |
| 8.4 | Two Means of Egress | | | | * | * | * |
| 8.0 | Seats in good working order | | | | * | * | * |
| 8.0 | Gauges and Controls clearly labeled and operable | | | | * | * | * |
| 8.0 | Windows serviceable and secure | | | | * | * | * |
| 9. MAINTENANCE SYSTEMS | | | | Y/N | SO | OC | UG |
| 9.1 | Pre-Start Inspection System in place | | | | * | * | * |
| 9.2 | Emissions Testing System in place | | | | | | * |
| 9.3 | Scheduled Brake Testing System in place | | | | * | * | * |
| 10. CRANAGE AND LIFTING | | | | Y/N | SO | OC | UG |
| | Not Applicable | | | n/a | n/a | n/a | n/a |
| 11. VEHICLE MOUNTED CRANES | | | | Y/N | SO | OC | UG |
| 11.4 | Certification as per AS 1418.10 and AS 2550.10 | | | | * | * | * |
| 11.0 | Boom and Luff Mechanism in serviceable condition | | | | * | * | * |
| 11.0 | Slew Mechanism (where fitted) in serviceable condition | | | | * | * | * |
| 11.0 | Load Charts located on crane | | | | * | * | * |
| 11.0 | Crane Controls clearly labeled and protected | | | | * | * | * |
| 12. TYRES/TRACK SYSTEMS | | | | Y/N | SO | OC | UG |
| 12.0 | Tyres free of visible damage/bulges, adequate tread depth/inflation | | | | * | * | * |
| 12.0 | Rims free of visible damage, valve stem secure, all wheel nuts in place | | | | * | * | * |
| 12.0 | Tracks free of visible damage, idler cover plates in place, track bolts secure | | | | n/a | n/a | n/a |
| 13. OTHER | | | | Y/N | SO | OC | UG |
| 13.0 | Body in good condition with no sharp/protruding edges | | | | * | * | * |
| 13.0 | Trays (if fitted) in good condition and suitable for the tasks required | | | | * | * | * |
| 13.0 | No Major Fluid Leaks (oil, brake, transmission and hydraulic fluids) | | | | * | * | * |

OTML Representative Comments

| |
|--|
| |
| |
| |
| |
| |

VEHICLE OWNER

I certify the above vehicle has been inspected by an authorized person and has satisfactory met the minimum site standards required for mobile equipment and vehicles. The equipment is to the manufacturers specifications and is being serviced and maintained by competent personnel to the manufacturer's recommendations.

| Company | Name | Role | Signature | Date |
|---------|------|------|-----------|------|
| | | | | |

OTML REPRESENTATIVE

- This vehicle complies with site requirements as established through the corresponding Site Permit Request for its use and area use.
- This vehicle does not comply with site requirements as established through the corresponding Site Permit Request for its use and area use. Please rectify the identified faults and re-present the vehicle for further inspections.

| Name | Signature | Date |
|------|-----------|------|
| | | |

Original (including copies of attachments): retained for site record
Copies to: Permit Requester and OTML Representative where inspection approved
Copies to: Permit Requester where inspection not approved

10. KEY CONTROLS INDEX

B

Barricades 3

C

Communication

- Horn signals 8
- Mobile phone 8
- Two-way radio 6, 13

E

Emergency response and equipment 20

Equipment

- Maintenance and servicing 6
- Pre-start 5
- Registered and authorised for use 5
- ROPs, FOPs and occupant protection 4

H

Horn signals 8

L

Lighting 3

Loads 17

- Limits 17
- Load restraint 17

P

PPE 4

R

Reversing alarm 13

Road design, construction and maintenance 3

Road rules 7

S

Segregation of vehicles and pedestrians 3

Separation of light and heavy vehicles 15

Signs 3

Speed limits 7

Spotter 14

T

Trained and authorised 4

- Defensive driving techniques 7
- Licensed 7
- Site and route familiarisation 7

